

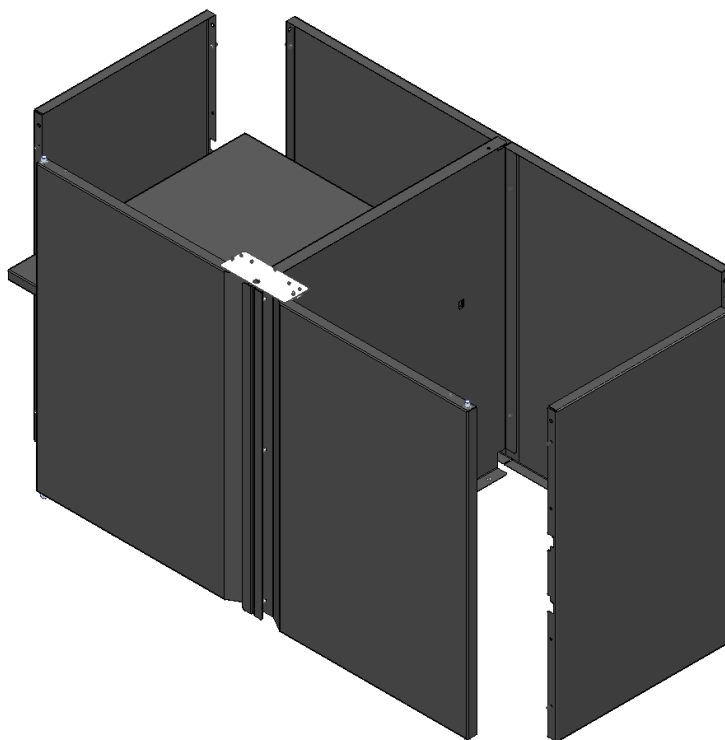

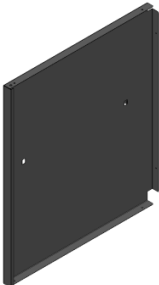

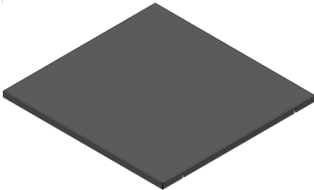

"KMAP12085"

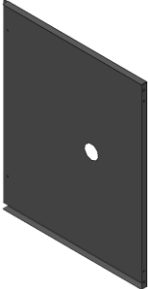
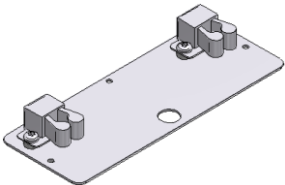

Composition du kit

Rep.	Qté	Désignation	Rep.	Qté	Désignation	Rep.	Qté	Désignation
1	1		4	1		7	2	
						6	4	
2	2		5	2		8	2	
						9	35	
3	2		6	1		T1	1	